



Design and implementation of Orchard Internet of Things based on LoRa

Yanjun Hu ^{1*}, Pingchuan Zhang ², Ye Zhang ³, Zhao Chen ⁴, Xue Chen ⁵, Caihong Zhang ⁶, Shan Li ⁷

^{1, 2, 4, 7} School of Information Engineering, Henan Institute of Science and Technology, Xinxiang 453003, China

⁶ School of Mechanical and Electrical Engineering, Xinxiang University, Xinxiang 453003, China

^{1, 3} School of Information Engineering, Zhengzhou Electric Power Technology College, Zhengzhou 451450, China

* Corresponding Author: **Yanjun Hu**

Article Info

ISSN (online): 2582-7138

Volume: 03

Issue: 04

July-August 2022

Received: 17-07-2022

Accepted: 02-08-2022

Page No: 470-477

Abstract

Traditional orchards require a lot of manpower to manage orchards, and due to the limitations of orchard managers' experience and other factors, the management level of orchards is not high, which easily leads to problems such as low fruit yield and poor quality. The rapid development of Internet of Things technology provides technical support for the realization of intelligent management in various fields. In order to facilitate the environmental monitoring and management of small and medium orchards, this paper designs a low-cost Internet of Things-based orchard environmental monitoring and control system. In this paper, Arduino Nano is used as the main control, and DHT11 air temperature and humidity sensor, soil humidity sensor, and BH1750FVI light intensity sensor are used to collect the environmental parameters of the orchard, display the parameters on the OLED12864 display screen, and use the serial port to transmit it to the host computer, which is convenient for the administrator to monitor and control the data in real time. According to the monitoring data, corresponding measures are taken in a timely manner. When the air humidity in the orchard is not enough, the humidification device will be automatically turned on. When the soil humidity is insufficient, the soil humidification device will be turned on automatically. When the humidity is suitable, it will be turned off growth, thereby improving product quality. The design of this paper realizes low cost, relatively rich system functions, simple and practical operation, and brings great convenience to orchard management.

Keywords: Management, orchard, internet, environmental

1. Introduction

Traditional orchard management has problems such as insufficient management level, inadequate control of environmental conditions, and high labor costs. The Internet of Things technology has gradually matured. How to design a low-cost, practical, accurate and efficient Internet of Things system suitable for small and medium orchard management to replace the traditional orchard management method is an important topic of contemporary research.

Domestic and foreign researchers have done a lot of research and application design. J. Prem ^[1] of Swinburne University of Technology in Australia designed an agriculture-based monitoring platform, which can collect soil, humidity, fertilization and other environmental parameters by itself, and can effectively filter out invalid data, so as to intelligently Crops are forecasted effectively and reasonable suggestions are given. Zhao Wenxing and Wu Zhijing of East China Jiaotong University have designed and implemented an orchard environment monitoring system based on the Internet of Things, which collects various data such as environmental temperature and humidity, leaf humidity, and rainfall through the environmental collection nodes installed in the orchard, and transmits the data. Go to the control center and perform data analysis, and display these data to users through graphic tables ^[2].

Lin Finn ^[3] of Zhejiang University used multi-point collection to collect various parameters of the farmland environment, and combined it with geographic information through the Internet of Things to analyze it to realize the visual monitoring of the farmland climate. Huang Jiayao ^[4] and others designed an IoT environment monitoring system with Android Nano terminals, and used ZigBee technology to set up a local area network, and then transmitted the data to the host computer. Finally, the terminal received the data and displayed it on the terminal platform, realizing remote real-time monitoring. Ren Qiaoli ^[5] and others have used GPRS technology to design an environmental monitoring system, collect orchard temperature and light parameters through simulation, use GPRS to transmit data to the system cloud, and analyze and monitor the data. Li Xiaoyang ^[6] uses nodes, gateways and servers to form a software platform. Use the drone camera to collect raspberry growth information, and transmit the data to the software through the serial port to monitor the agricultural environment.

Although the above can realize orchard environmental monitoring, the cost is high. This paper aims to design a low-cost orchard monitoring system suitable for small and medium orchards, which can achieve a certain degree of control while realizing environmental monitoring. The orchard environment monitoring and control system designed in this paper uses the Internet of Things sensing technology to collect data information such as temperature, humidity and illuminance of the orchard ^[7-8], and then transmits the collected data to the microprocessor Arduino Nano, which is connected to The OLED12864 display screen displays these data in real time for managers to view at any time, and then transmits the parameters to the host computer through the USB serial port, stores and analyzes the data, and presents it to the user in the form of data, graphics, etc. The

administrator monitors the orchard and gives management feedback through the analysis of environmental parameters. In order to realize intelligent management, this paper also designs an automatic control water and light supplement device. This system can realize that when the soil humidity or light intensity is insufficient, the system automatically turns on the water supplement and light supplement device, and when the orchard environment reaches the suitable temperature, humidity and light intensity for fruit trees, the system automatically turns off the water supplement light device ^[9-12]. This system meets the current needs of the majority of small and medium orchard industries, solves the problems existing in traditional orchards, and improves management efficiency.

2. Overall Design of the System

The environmental monitoring system consists of sensor data acquisition module, Arduino microprocessor, USB serial port transmission module, automatic control module, and LabVIEW host computer. The sensing module includes a soil moisture sensing module, an air temperature and humidity sensing module, and a light intensity sensing module, which are responsible for collecting soil moisture, air temperature, humidity, and light in the orchard environment. The Arduino Nano microprocessor is responsible for collecting and transmitting these data, and the data is transmitted to the host computer LabVIEW software by USB transmission. The automatic control module is realized by the peripheral equipment, and the software part LabVIEW is responsible for programming the virtual equipment and the instrument to simulate the upper computer, which is used to visualize and control the collected data. The system design diagram is shown in Figure 1.

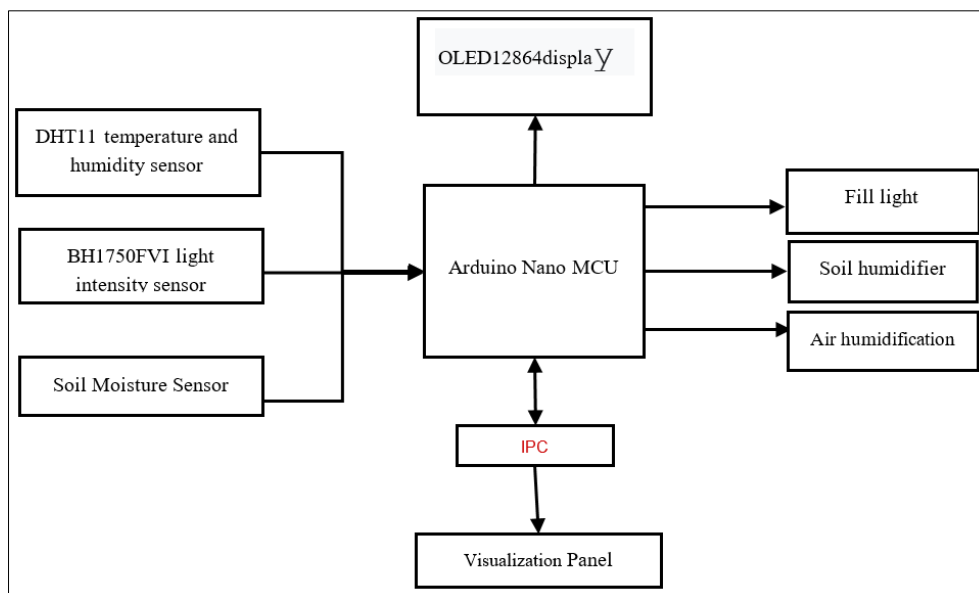

Fig 1: System scheme design drawing

3. System Design and Implementation

3.1. System hardware design and implementation

3.1.1. DHT11 temperature and humidity sensor

The temperature and humidity of the air environment is one of the important conditions for the healthy growth of fruit trees. The healthy growth of fruit trees requires that the temperature should not be higher than 30 degrees, and the

optimum temperature is about 25 degrees. In winter, the air temperature is best not lower than minus 10 degrees to prevent fruit trees from being frostbitten and reduce production. It is best to control the air humidity at about 80%. If the humidity is too low, the fruit quality will decrease. When the temperature and humidity exceed or fall below the optimum threshold, peripheral devices need to be triggered to

adjust the orchard environment through manual intervention. In this paper, the air temperature and humidity monitoring of the sensing module adopts the DHT11 temperature and humidity sensor to collect the air temperature and humidity. DHT11 is a very commonly used composite sensor. The temperature and humidity data it collects and outputs are digital data output after calibration. The digital acquisition technology he uses is very accurate, and the sensing technology is relatively advanced at present, which makes it highly stable and the accuracy of the collected data is also extremely high. DHT11 digital humidity temperature sensor is composed of a resistive humidity sensing element and an NTC temperature measuring element. It is connected to a high-performance 8-bit single-chip microcomputer. Its use is also very simple. It only needs one I/O port to connect the control terminal and the sensing module. Multiport. The data format adopts a single bus format^[13]. It has the advantages of first-to-measure measurement, calibration output digital function, strong resistance to interference, fast response, high cost performance, low power consumption, etc., and no other components are required. The sensor is shown in Figure 2, and the DHT11 temperature and humidity sensor pins are shown in Table 1.

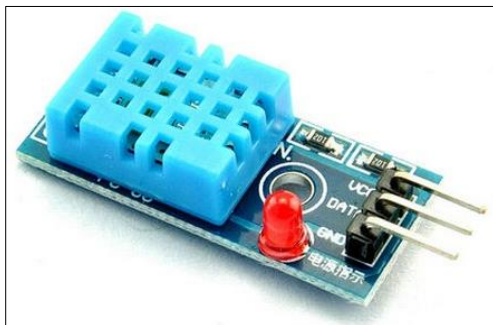

Fig 2: DHT11 Temperature and humidity sensor

Table 1: DHT11 Temperature and humidity sensor pin definition table

Pin Number	Pin Name	Pin Description
1	VDD	powered by,3~5.5VDC
2	DATA	Serial data, single bus
3	NC	Empty feet, please leave it in the air
4	GND	ground, power negative

3.1.2. Soil Moisture Sensor

The control of soil moisture is extremely important. Fruit trees like moisture but are afraid of waterlogging. Only by maintaining proper soil moisture can fruit trees grow and produce fruit well. Otherwise, root rot will occur, which will seriously affect orchard yield^[14].

The soil moisture acquisition module uses an ordinary soil moisture sensor, as shown in Figure 3. This soil sensor is very cheap and suitable for large-scale use in orchards. The outer surface of the sensor is plated with a layer of nickel, which improves the conductivity and has a long service life. It is not easy to rust when exposed to wet soil for a long time. This sensor is suitable for various agricultural environments, such as greenhouses, fields, gardens and orchards. It is small in size and easy to use, and there are bolt holes that can be used for fixing. The potentiometer knob in the module is the threshold adjustment button for soil humidity. The humidity controlled by clockwise adjustment becomes larger, and the counterclockwise adjustment becomes smaller.

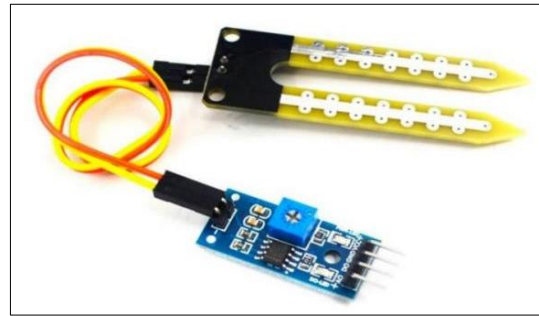

Fig 3: Soil Moisture Sensor

3.1.3. BH1750FVI light intensity sensor

The monitoring of light intensity in orchards is also essential. Fruit trees like light but are afraid of the sun, so it is better to tolerate shade. If the light is insufficient, it will affect the photosynthesis of fruit trees, resulting in stunted fruit tree development, reduced yield and quality. In summer, when there is strong light at noon, prepare shading for fruit trees to prevent water loss of fruit trees.

This paper uses the BH1750FVI light intensity sensor. The sensor is shown in Figure 4. It is a digital light sensor with a built-in 16bitAD converter, which omits complex calculations and directly outputs numbers. It has high resolution, and has spectroscopic characteristics similar to visual sensitivity. It can output the value of corresponding brightness, and supports 12CBUS interface. It does not require external components for monitoring stability, and the error is small. It is suitable for large-scale monitoring of orchards and long-distance transmission. Its pin definition is shown in Table 2.

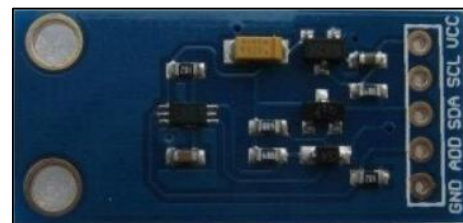

Fig 4: Light Intensity Sensor

Table 2: BH1750FVI light intensity sensor pin definition table

Pin Number	Pin Name	Pin Description
1	VCC	Power supply positive electrode,3~5 VND
2	SCL	IIC clock line, clock input pin, output clock from MCU
3	SDA	IIC data line, bidirectional IO port, used to transmit data
4	GND	Power supply negative electrode
5	ADDR	IIC address line

3.1.4. Arduino microcontroller

The system requires a microprocessor to collect and transmit environmental parameters. This paper selects the Arduino main control chip. Arduino is an open source code including hardware and software, which is convenient and practical. The Arduino control board can collect data through sensors, and make feedback by controlling peripheral devices to achieve the purpose of automatic control. At present, two main control chips, Arduino Uno and Nano, are widely used in the market. This system uses Arduino Nano as the main

board, the main board picture is shown in Figure 5. Arduino microcontrollers are inexpensive and easily available. And the burning program is also very simple and convenient, you can use the USB interface to burn. Wired and wireless input devices can be constructed using Arduino without limitation [15].

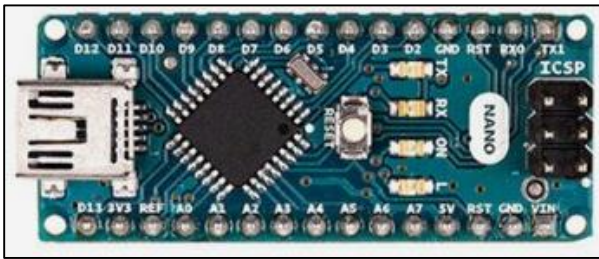

Fig 5: Arduino Nano MCU

3.1.5. OLED12864 display

OLED screen is a very commonly used display technology. The screen is bright and white, the contrast is high, and the screen power consumption is very low, so it is widely used in various fields. Generally, the 128X64 resolution screen is only 0.96 inches. It has a good display effect and is easy to carry. As shown in Figure 6.



Fig 6: OLED12864 Display

3.2. System software design and implementation

3.2.1. Main program design and implementation

The main function of the orchard environmental monitoring system is to monitor the environment. The upper computer needs to communicate with the lower single-chip microcomputer, send commands to the sensor acquisition module, collect data, and then receive the environmental data sent by the sensor module to analyze and visualize the data. The system can automatically control the opening and closing of the peripheral humidifier and the supplementary light device, and realize the function of replenishing water and light in the orchard.

This system realizes that each subroutine module is controlled by Arduino Nano single-chip microcomputer to work, and its code content is written by Keil software. The single-chip microcomputer receives the instructions sent by the upper computer and controls the sensor module to collect orchard environmental parameters, process the data, and control the display module. The parameters are displayed on the LED screen in real time, and the parameters are compared with the set thresholds to determine whether the control module is turned on or off, so as to ensure the normal display

and operation of the functions of the entire orchard environmental monitoring system. The main program flow chart of the orchard environmental monitoring system is shown in Figure 7.

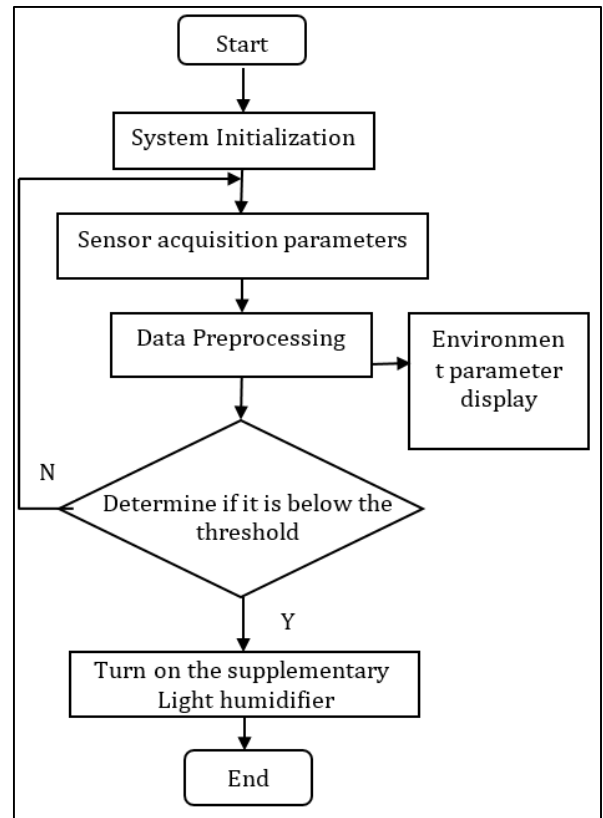

Fig 7: Flow chart of the main program of the orchard environmental monitoring

3.2.2. Main subroutine design

The system controls the work of each subroutine module through the main chip Arduino. The subroutine sensor module is composed of sensors connected to the main chip. If the acquisition command is received, the sensor will collect the orchard environmental information by analog signal, and then convert it into digital. If the sensor receives the stop signal, it will send the last collected data to the microcontroller. The flow chart of the sensor module subroutine is shown in Figure 8.

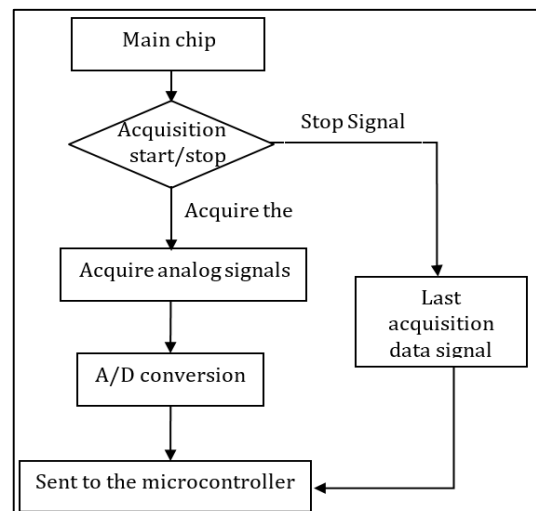

Fig 8: Sensing module subroutine flowchart

3.2.3. Serial communication module

The interaction mode between the host computer of this system and the single-chip microcomputer and the controlled equipment is the serial port. The information is transmitted in the form of serial communication. The data is transmitted sequentially one by one on a data line, and one bit is transmitted at the same time. The detailed transmission method is shown in Figure 9. The serial communication uses few transmission lines and can carry out remote Distance communication, but the rate is lower than other methods, this method has low cost and is more suitable for wide application. Serial communication includes simplex communication, half-duplex communication and full-duplex communication. Full-duplex communication allows bidirectional transmission of data, and both sides can be sent and received. The analytical diagram is shown in Figure 10. LabVIEW visa is required for serial communication, and the visa driver needs to be downloaded and installed before the

system runs. It should be noted that the visa needs to be consistent with the version of LabVIEW used. For serial communication, first initialize the serial port, configure the serial port number, baud rate, stop bit, parity bit and data bit through VISA ConfigUre Serial Port, then read and write the serial port through VISA Read and VISA Write, and finally close the serial port.

When the system starts to collect environmental data, according to the communication protocol, the host computer sends relevant parameters to the sensor module, and VISA Write is called at this time. When the data collection is completed and should be sent to the host computer, VISA Read is called. If you suddenly click to stop the system when receiving data, VISA Write and VISA Close are called, and commands are sent to stop the collection of environmental parameters and release the resources occupied by serial communication ^[16].

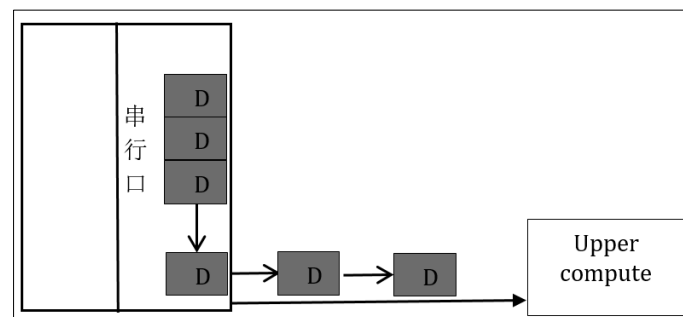

Fig 9: Serial communication transmission mode

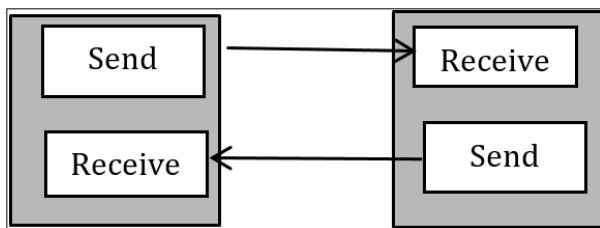

Fig 10: Analytical diagram of full-duplex communication

4. Upper Computer Design

4.1. LabVIEW programming

The LabVIEW virtual instrument used in this paper is composed of hardware with various functions and various flexible software that can simulate practical applications in various measurement and control fields ^[17]. Efficient simulation not only makes the system more stable, on the one hand It also greatly improves the efficiency of research and development. LabVIEW has a full-featured information processing and interaction module, which is convenient for users to process data efficiently and accurately. This system uses LabVIEW to complete the design of the upper computer, with good maintainability and short development cycle. It has rich control types, which ensures a good human-computer interaction experience and practicability of the monitoring

system ^[18].

In this paper, LabVIEW is used to design the monitoring main panel of the monitoring system. The main program design diagram is shown in Figure 4-1. The system consists of a while loop including all structures. Repeated execution of the code inside makes the system update the environmental parameters in real time, and then includes a Layer event structure, judge the operation and stop instructions of the system, each function runs normally when the system is running, click stop to stop collecting environmental parameters. The collected data is processed and displayed on the panel, and numerical controls are added to display it more intuitively through charts and other forms. The thermometer is used to display the air temperature, the turntable is used to display the air and soil moisture values, and the meter is used to display the light intensity. Set the optimal thresholds of various parameters, and set the value of the current environmental parameter value and the optimal value of fruit tree growth. When the temperature, humidity and illuminance are less than the set thresholds, the controlled Boolean light will light up, indicating that the supplementary light and water supplementation devices are turned on. When each parameter reaches the optimum value, the Boolean light turns off.

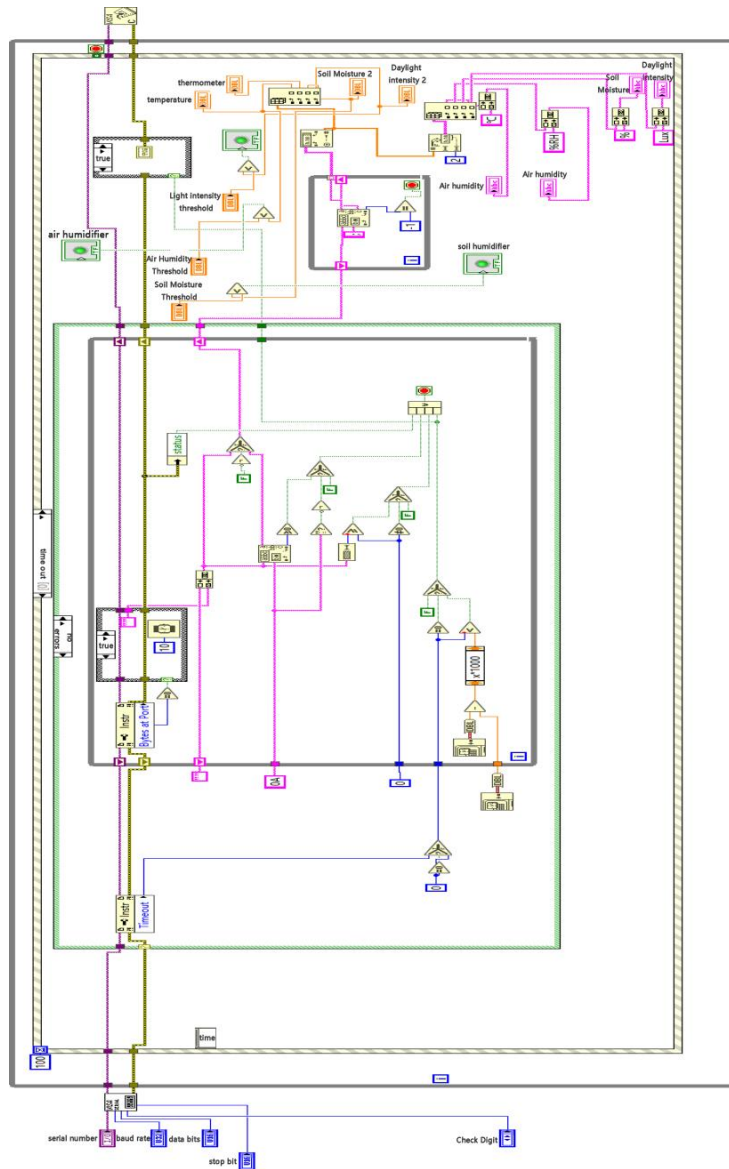

Fig 11: Lab VIEW Main program design

4.2. Lab VIEW Front panel design

The Lab VIEW front panel design is shown in Figure 12. There are communication serial port parameter configuration in the front panel, real-time display of various data in the panel, thermometer, humidity dial, light intensity meter, etc. This panel displays the received environmental parameters in intuitive numbers, and displays some data in the form of intuitive images of thermometers, dials and meters, giving users more intuitive and clearer orchard environmental data information, and facilitating managers to find problems in time and process it. There are threshold setting modules for various parameters on the right, which can be used to fill in and set the optimum temperature, humidity and light for fruit trees. When the real-time environmental parameters do not reach the set value, the water supplement and light supplement device is automatically turned on to meet the growth needs of fruit trees in time. Automatically shut down peripherals when optimal growth conditions are reached.

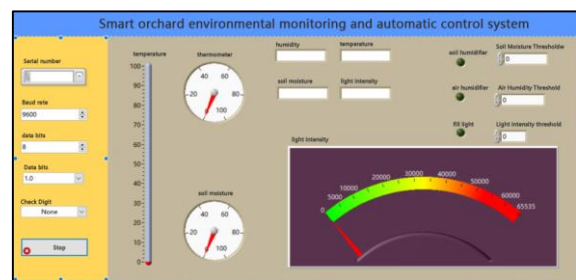

Fig 12: LabVIEW Front panel

5. System Test

5.1. Hardware functional test

Connect each sensor module to the main board and connect to the power supply. You can see that each module is working normally. The screen can also display the data of air temperature and humidity, illuminance and soil humidity in real time. The working status of the sensor and microprocessor modules is shown in Figure 13 shown.

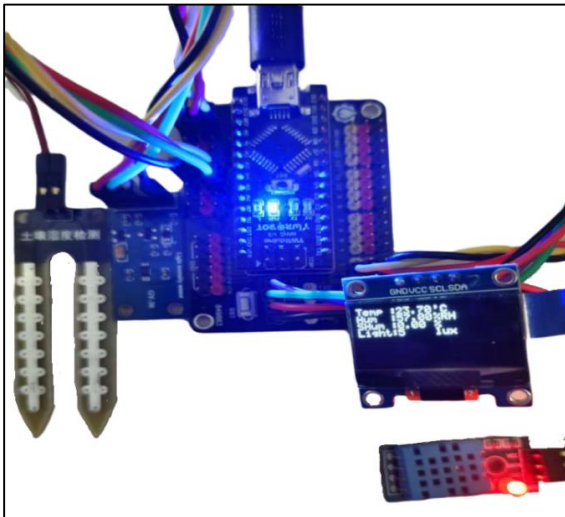

Fig 13: Sensing Module Connection Test Diagram

5.2. Upper computer system test

All sensor modules and microprocessor modules are working normally, then connect to the computer through the USB serial port, open the front panel of LabVIEW, select COM3 serial port at the serial port number, and then click Run to successfully connect and run to transfer the data to LabVIEW, and the acquisition results are shown in the figure 14. The current air temperature shown in 14 is 25 degrees, the air humidity is 55.00%RH, the soil humidity is 0%, and the light intensity is 15.00Lux. The displayed values are also displayed intuitively in the image. In the upper right corner, you can set an optimum value for each parameter. When the real-time data is less than the set threshold, the corresponding control device on the left lights up and works. The working situation is shown in Figure 15. When the real-time data is greater than the threshold, the control device is turned off.

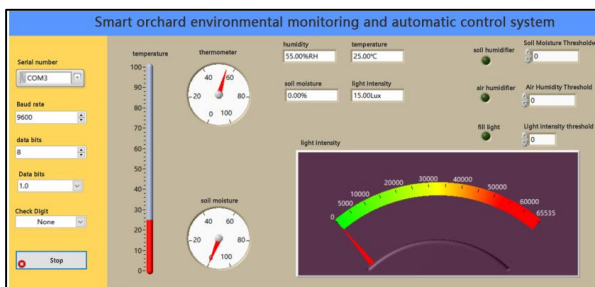

Fig 14: Upper computer front panel

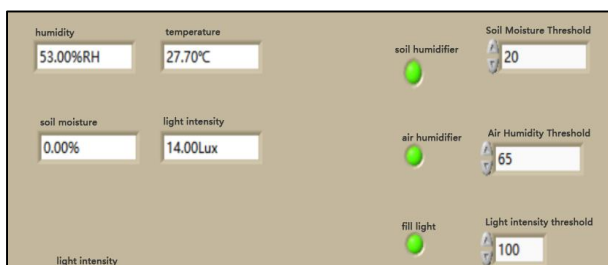

Fig 15. Threshold setting and working diagram of control equipment

6. Conclusion

The orchard environment monitoring and control system designed in this paper receives the acquisition/stop command

from the host computer through the Arduino Nano microcontroller, drives the DHT11 temperature and humidity sensor, BH1750FVI light intensity and soil humidity sensor to collect environmental parameters, and displays them on the OLED12864 screen in real time the single-chip microcomputer sends the data to the host computer LabVIEW after micro processing. The host computer further processes the data and outputs it with graphics such as thermometer, humidity dial, and light intensity meter, which is more convenient for managers to observe. LabVIEW compares the real-time data with the preset parameter thresholds. When the parameters cannot reach the set optimum values, the adjustment device is turned on to automatically adjust the orchard environment.

This paper meets the current needs of the orchard industry, and solves the problem of the old management model of traditional orchard technology and the waste of human resources. The orchard environment monitoring system can remotely monitor the orchard environment in real time, saving a lot of human management resources and improving management efficiency. On the other hand, the system's accurate detection and control of the orchard environment can allow managers to take timely feedback measures to improve the growth efficiency of fruit trees, and to a certain extent, it can improve the yield and product quality of the orchard. The cost of this design is low, but the function is powerful and efficient, so it has good practicability and is suitable for use in various small and medium orchards.

7. References

- Jayaraman PP, Yavari A, Georgakopoulos D, Morshed A, Zaslavsky A. Internet of things platform for smart farming: Experiences and lessons learnt. *Sensors*. 2016;16(11):1884.
- Zhao WX, Wu ZJ, Liu DL, Liu YD. Design of orchard environment intelligent monitoring system based on agricultural Internet of Things. *Jiangsu Agricultural Sciences*. 2016;44(05):391-394. DOI:10.15889/j.issn.1002-1302.2016.05.114.
- Lin LF, Wang RS, Yu PH. GIS Based Visual Monitoring System of Farmland Microclimate Environment. *Transactions of the Chinese Society for Agricultural Machinery*. 2015;46(03):254-260.
- Huang JY, Zhou Q, Zhang SY. IoT wireless environment monitoring system based on Android terminal. *Electronic Technology & Software Engineering*. 2018;(03):26-27.
- Ren XL, Chen JX, Wang J. Study on online environment monitoring system based on GPRS technology. *Modern Electronics Technique*. 2015;38(04):60-62+65.
- Wang Y, Du HY, Zhao XH. Node Analysis of Wireless Sensor Network for Orchard Environmental Monitoring. *China Agricultural Information*. 2017;(16):52+54.
- Ma LH, Gao QQ, Chang Y, et al. Research on the realization of orchard environmental monitoring system based on Internet of Things technology. *Agriculture and Technology*. 2019;39(13):22-23.
- Wu ZA. Design of automatic detection and regulation system of temperature and humidity in greenhouse. *Public Communication of Science & Technology*. 2018;10(21):100-101.
- Yang F. Design of real-time monitoring system for temperature and humidity of granary based on single chip microcomputer. *Hubei Agricultural Sciences*.

- 2016;55(09):2370-2372.
10. Zhang QY. Design of Horticultural Environment Monitoring System. *Communications Science and Technology Heilongjiang*. 2020;43(12):195-196.
 11. Chen WB, Peng ZX, Zeng GH, Wang JY, Guo DB. Design and Implementation of a Wireless Temperature Sensor. *Journal of Hunan University of Technology*. 2012;26(03):87-90.
 12. Bao RF. Research on the application of Arduino microcontroller in information technology education. *Software Guide*. 2015;14(06):224-225.
 13. Li HG, Zhang SP. Design of multi-channel data acquisition system based on single chip microcomputer and LabVIEW. *Foreign Electronic Measurement Technology*. 2014;33(04):62-67.
 14. GU X. Design and implementation of Taishan tea environmental control system based on Internet of Things [D]. Taian: Shandong Agricultural University; c2020.
 15. Bao RF. Research on the application of Arduino microcontroller in information technology education. *Software Guide*. 2015;14(06):224-225.
 16. Li HG, Zhang SP. Design of multi-channel data acquisition system based on single chip microcomputer and LabVIEW. *Foreign Electronic Measurement Technology*. 2014;33(04):62-67.
 17. Liu JF. Design of Data Acquisition and Multifunctional Analysis System Based on LabVIEW. TaiyuanL: North University of China; c2015.
 18. Han Q. Research and Design of Data Acquisition and Analysis System Based on Virtual Instrument. Beijing Jiaotong University; c2012.